



FortiFone™ QuickStart Guide  
for FON-475



## FortiFone™ QuickStart Guide for FON-475

Revision 1

August 15, 2018

Copyright © 2018 Fortinet, Inc. All rights reserved. Fortinet®, FortiGate®, FortiCare® and FortiGuard®, and certain other marks are registered trademarks of Fortinet, Inc., in the U.S. and other jurisdictions, and other Fortinet names herein may also be registered and/or common law trademarks of Fortinet. All other product or company names may be trademarks of their respective owners. Performance and other metrics contained herein were attained in internal lab tests under ideal conditions, and actual performance and other results may vary. Network variables, different network environments and other conditions may affect performance results. Nothing herein represents any binding commitment by Fortinet, and Fortinet disclaims all warranties, whether express or implied, except to the extent Fortinet enters a binding written contract, signed by Fortinet's General Counsel, with a purchaser that expressly warrants that the identified product will perform according to certain expressly-identified performance metrics and, in such event, only the specific performance metrics expressly identified in such binding written contract shall be binding on Fortinet. For absolute clarity, any such warranty will be limited to performance in the same ideal conditions as in Fortinet's internal lab tests. In no event does Fortinet make any commitment related to future deliverables, features or development, and circumstances may change such that any forward-looking statements herein are not accurate. Fortinet disclaims in full any covenants, representations, and guarantees pursuant hereto, whether express or implied. Fortinet reserves the right to change, modify, transfer, or otherwise revise this publication without notice, and the most current version of the publication shall be applicable.

FortiVoice	<a href="https://fortivoice.com">fortivoice.com</a>
Technical Documentation	<a href="https://docs.fortinet.com">docs.fortinet.com</a>
Knowledge Base	<a href="https://kb.fortinet.com">kb.fortinet.com</a>
Customer Service & Support	<a href="https://support.fortinet.com">support.fortinet.com</a>
Training Services	<a href="https://training.fortinet.com">training.fortinet.com</a>
FortiGuard	<a href="https://fortiguard.com">fortiguard.com</a>
Document Feedback	<a href="mailto:techdocs@fortinet.com">techdocs@fortinet.com</a>

# Contents

<b>Introduction</b> .....	<b>1</b>
Box includes .....	1
<b>Installation</b> .....	<b>2</b>
Attaching the stand.....	2
Connecting the phone .....	3
Setting up the phone .....	4
For use as an internal extension .....	4
For use as an external extension .....	4
<b>Using the Phone</b> .....	<b>5</b>
<b>Troubleshooting</b> .....	<b>7</b>
<b>Cautions and Warnings</b> .....	<b>8</b>
Environmental specifications.....	8
Safety.....	8
E911 and use with multi-line telephone systems .....	8
Privacy .....	9
<b>Regulatory Notices</b> .....	<b>10</b>
Federal Communication Commission (FCC) – USA .....	10
European Conformity (CE) – EU.....	11
Industry Canada Equipment Standard for Digital Equipment (ICES) – Canada .....	11
<b>Warranty</b> .....	<b>12</b>



# Introduction

This guide describes how to set up your phone and provides a brief overview of its features. Start by configuring an extension in the phone system. Refer to the *FortiVoice Administration Guide* for information about configuring an extension.

For further details about your phone, please see the *FON-475 User Guide*.

## Box includes

The following items are included in the box:



**IP Phone**



**Handset**



**Base Bracket**



**Handset Cord**



**Ethernet Cable**

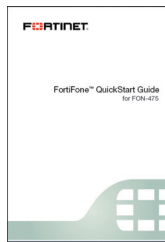

**QuickStart Guide**

# Installation

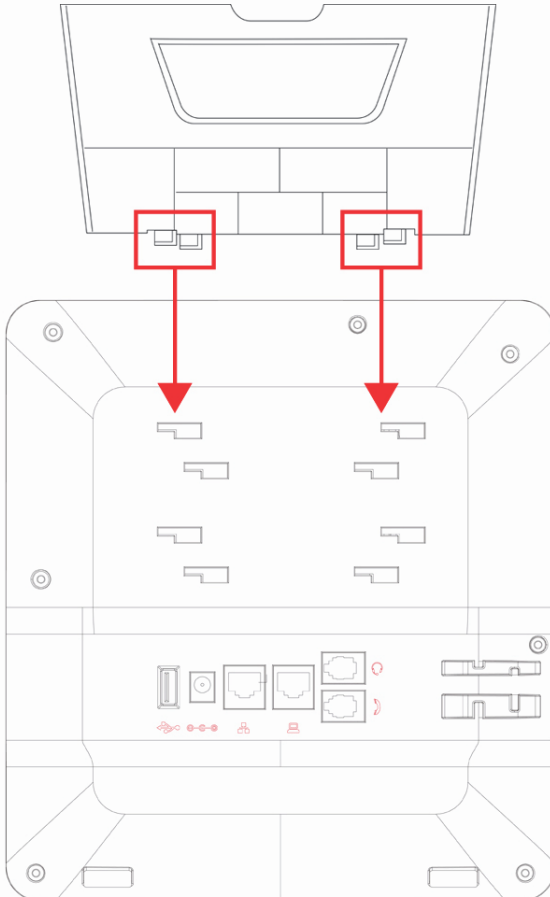

## Attaching the stand

1. Line the four posts of the base with the four holes on the back of the phone, depending on the level of tilt preferred.
2. Slide sideways into place until secure.

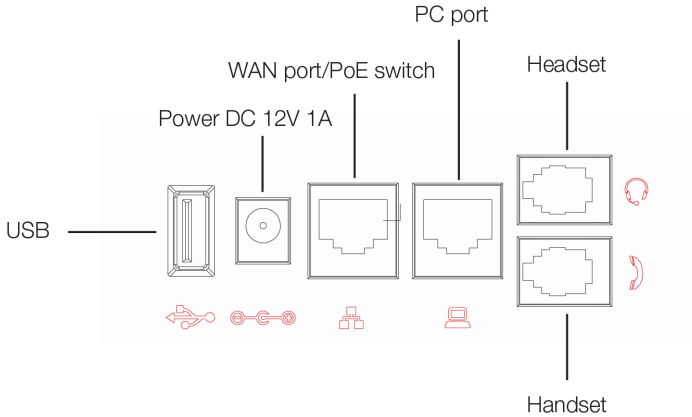

# Connecting the phone



1. Connect the handset cord to the handset  jack on the phone.
2. Optionally, connect an amplified headset to the  jack.
3. Connect the WAN port to the network with the provided Ethernet cable.
4. Optionally, connect your desktop PC to the PC port with an Ethernet cable (not supplied).
5. If the network supports PoE, a power adapter is not required. The phone requires 5.7 W to function with PoE. If PoE is not supported on the network, connect the power adapter to the DC 12V 1A power jack.

# Setting up the phone

## For use as an internal extension

The phone supports plug and play installation and will automatically download its configuration from the FortiVoice system. The phone will display the extension number and name when it has registered.

Once configured within the FortiVoice system, reboot the phone to download its configuration and register to the system.

## For use as an external extension







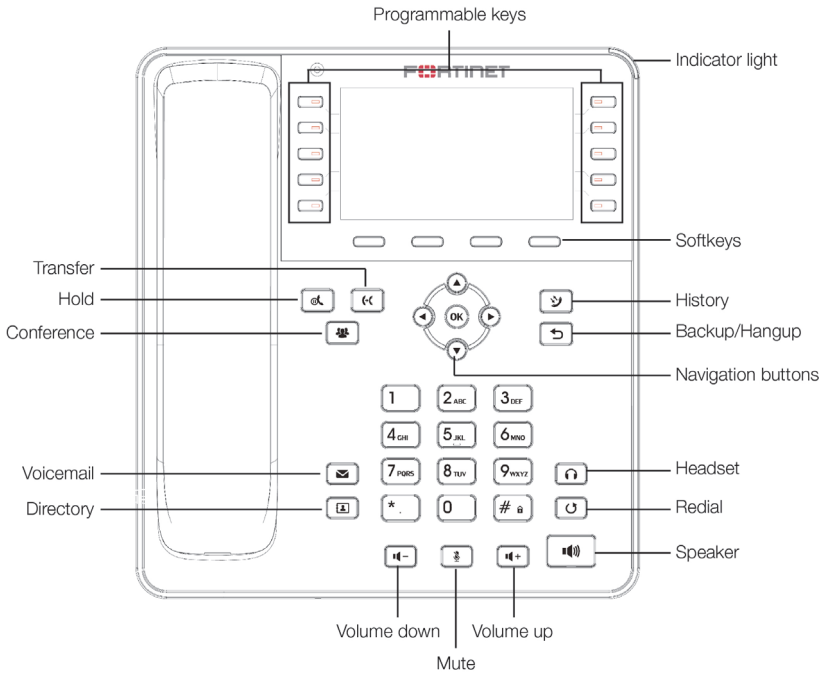



1. On the phone, press the *Menu* button.
2. Select *Advanced*.
3. Enter the password as 23646.
4. Select *Maintenance*.
5. Select *Auto Provision*.
6. Select *Static Provisioning Server*.
7. Set the *Mode* to *After Reboot*.
8. Press the down arrow and set the *Protocol* to *TFTP*.
9. Press the down arrow and set the *Server* as the public IP Address of the FortiVoice.
10. Press *Save*.
11. Now return to the *Main Menu* and select *Basic > Reboot System*.



# Using the Phone



Softkey	Function
<i>History</i>	Accesses the history of calls with this phone.
<i>Directory</i>	Accesses the contacts stored on the phone.
<i>DND</i>	Toggles Do Not Disturb on and off.
<i>Menu</i>	Accesses the <i>Settings</i> menu.

Button	Function
	<i>Hold</i> — places and retrieves calls on hold.
	<i>Transfer</i> — transfers calls to another extension or outside line.
	<i>Conference</i> — brings multiple calls together in a conference.
	<i>Voicemail</i> — accesses voicemail and voicemail greetings.
	<i>Redial</i> — places a call to the last number dialed.
	<i>Mute</i> — toggles the microphone on and off.
	<i>Headset</i> — toggles the headset on and off.
	<i>Speakerphone</i> — toggles the speaker on and off.
	<i>Directory</i> — accesses contacts stored on the phone.
	<i>History</i> — accesses the history of calls with this phone.
	<i>Backup/Hangup</i> — while in a menu, it will return to the previous menu. While on a call, can be used as a hangup.

# Troubleshooting

Symptom	Corrective Action
Display is blank	<p>Confirm the phone's power source.</p> <ol style="list-style-type: none"><li>1. If you are using the power adapter:<ul style="list-style-type: none"><li>• Ensure it is plugged in. If it still doesn't work, replace the power adapter.</li></ul></li><li>2. If you are using Power over Ethernet (PoE):<ul style="list-style-type: none"><li>• Ensure your Ethernet cable is plugged into the WAN port on the back of your phone.</li><li>• Ensure the PoE switch is properly configured. If it still doesn't work, replace the Ethernet cable.</li></ul></li></ol>
Phone not receiving a DHCP IP Address	<p>The DHCP server is not responding.</p> <ol style="list-style-type: none"><li>1. Ensure your DHCP server is online. This is typically your router.</li><li>2. Reboot the router or DHCP server.</li><li>3. If you are still experiencing issues, the phone may require advanced network configuration. Please contact your administrator or refer to the <i>FON-475 User Guide</i>.</li></ol>
<i>No name and Extension Number is displayed</i>	<p>Your phone is not registered.</p> <ol style="list-style-type: none"><li>1. On the <i>Extensions</i> page of the FortiVoice interface, ensure the MAC address is correctly entered and the <i>Phone Type</i> is <i>FON-475</i>. Save your configuration and reboot the phone.</li><li>2. On the phone, ensure the <i>Server</i> is correct. To verify, see "<a href="#">For use as an external extension</a>".</li><li>3. If your phone is configured as an external extension, check the network connection and firewall settings at the phone system location.</li></ol>
No audio during a call	<ol style="list-style-type: none"><li>1. Check the handset/headset connections.</li><li>2. Make sure the phone is properly registered with the phone system.</li><li>3. If your phone is configured as an external extension, check the network connection and firewall settings at the phone system location.</li></ol>

# Cautions and Warnings

## Environmental specifications

Refer to specific Product Model Data Sheet for Environmental Specifications (Operating Temperature, Storage Temperature, Humidity, and Altitude).

Référez à la Fiche Technique de ce produit pour les caractéristiques environnementales (Température de fonctionnement, température de stockage, humidité et l'altitude).

## Safety



**Caution:** This equipment is to be used in a Network Environment 0 per IECTR 62101. This product is connected only to PoE networks without routing to the outside plant.

**Attention :** Ce matériel doit être utilisé dans un Environnement Réseau 0 par IECTR 62101. Ce produit est uniquement connecté aux réseaux PoE sans installation externe de routage.

This product is intended to be supplied by a Listed Direct Plug-In Power Unit marked LPS or Class 2 and rated 5 Vdc, 2 A or by 48 Vdc from PoE source.

Le produit doit être alimenté par un bloc d'alimentation à courant continu homologué UL de 12 Vdc, 2 A nominal marqué LPS ou Class 2 ou par une source d'alimentation par Ethernet de 48 Vdc (PoE).

## E911 and use with multi-line telephone systems

Please note the use and operation of this phone as part of a multi-line telephone system (MLTS) may be subject to state and/or federal E911 MLTS laws that require the MLTS to provide a caller's telephone number, extension, and physical location to applicable state and/or local emergency services when a caller initiates a 911 call. The MLTS may not provide a caller's telephone number, extension, or physical location information to emergency services when a caller dials 911, and compliance with state and/or federal E911 MLTS laws is the sole responsibility of the purchaser of this phone.

# Privacy

This phone implements security and encryption technologies. However, privacy of communications may not be ensured when using this telephone.

# Regulatory Notices

## Federal Communication Commission (FCC) – USA

This device complies with Part 15 of FCC Rules. Operation is subject to the following two conditions:

1. this device may not cause harmful interference, and
2. this device must accept any interference received; including interference that may cause undesired operation.

This equipment has been tested and found to comply with the limits for a Class B digital device, pursuant to Part 15 of the FCC Rules. These limits are designed to provide reasonable protection against harmful interference in residential installation. This equipment generates, uses, and can radiate radio frequency energy, and if it is not installed and used in accordance with the instruction manual, it may cause harmful interference to radio communications. However, there is no guarantee that interference will not occur in a particular installation.

If this equipment does cause harmful interference to radio or television reception, which can be determined by turning the equipment off and on, the user is encouraged to try to correct the interference by one or more of the following measures:

- Reorient or relocate the receiving antenna.
- Increase the separation between the equipment and receiver.
- Connect the equipment into an outlet on a circuit different from that to which the receiver is connected.
- Consult the dealer or an experienced radio/TV technician for help.



**Warning:** Any changes or modifications to this unit not expressly approved by the party responsible for compliance could void the user's authority to operate the equipment.

---

## **European Conformity (CE) – EU**

This is a Class B product. In a domestic environment, this product may cause radio interference, in which case the user may be required to take adequate measures.



## **Industry Canada Equipment Standard for Digital Equipment (ICES) – Canada**

This Class B digital apparatus complies with Canadian ICES-003.

# Warranty

This phone is covered by a one-year hardware warranty against manufacturing defects as set forth in the EULA.

[www.fortivoice.com/support](http://www.fortivoice.com/support)

For warranty service:

- ***In North America***, please call 1-866-648-4638 for further information.
- ***Outside North America***, contact your sales representative for return instructions.

You will be responsible for shipping charges, if any. When you return this telephone for warranty service, you must present proof of purchase.



