



FortiFone™ User Guide  
for FON-375



## FortiFone™ User Guide for FON-375

Revision 1

October 5, 2016

Copyright© 2016 Fortinet, Inc. All rights reserved. Fortinet®, FortiGate®, FortiCare® and FortiGuard®, and certain other marks are registered trademarks of Fortinet, Inc., in the U.S. and other jurisdictions, and other Fortinet names herein may also be registered and/or common law trademarks of Fortinet. All other product or company names may be trademarks of their respective owners. Performance and other metrics contained herein were attained in internal lab tests under ideal conditions, and actual performance and other results may vary. Network variables, different network environments and other conditions may affect performance results. Nothing herein represents any binding commitment by Fortinet, and Fortinet disclaims all warranties, whether express or implied, except to the extent Fortinet enters a binding written contract, signed by Fortinet's General Counsel, with a purchaser that expressly warrants that the identified product will perform according to certain expressly-identified performance metrics and, in such event, only the specific performance metrics expressly identified in such binding written contract shall be binding on Fortinet. For absolute clarity, any such warranty will be limited to performance in the same ideal conditions as in Fortinet's internal lab tests. In no event does Fortinet make any commitment related to future deliverables, features or development, and circumstances may change such that any forward-looking statements herein are not accurate. Fortinet disclaims in full any covenants, representations, and guarantees pursuant hereto, whether express or implied. Fortinet reserves the right to change, modify, transfer, or otherwise revise this publication without notice, and the most current version of the publication shall be applicable.

FortiVoice	<a href="http://fortivoice.com">fortivoice.com</a>
Technical Documentation	<a href="http://docs.fortinet.com">docs.fortinet.com</a>
Knowledge Base	<a href="http://kb.fortinet.com">kb.fortinet.com</a>
Customer Service & Support	<a href="http://support.fortinet.com">support.fortinet.com</a>
Training Services	<a href="http://training.fortinet.com">training.fortinet.com</a>
FortiGuard	<a href="http://fortiguard.com">fortiguard.com</a>
Document Feedback	<a href="mailto:techdocs@fortinet.com">techdocs@fortinet.com</a>

# Contents

- Introduction..... 1**
  - Phone features..... 1
  - Programmable keys..... 2
  - Display layout..... 2
- Installation..... 3**
  - Attaching the stand..... 3
    - For desktop use ..... 3
    - For wall mounting ..... 3
  - Connecting the phone ..... 4
  - Setting up the phone ..... 5
    - For use as an internal extension ..... 5
    - For use as an external extension ..... 5
- Personalizing your Phone..... 6**
  - How to navigate through menus..... 6
  - Entering values with the dial pad and softkeys ..... 6
- Configuration Overview ..... 7**
  - Status..... 7
  - Features ..... 7
    - Auto hangup..... 7
    - Call waiting..... 7
    - DND..... 7
    - Blocking anonymous call ..... 7
    - Ban outgoing..... 7
    - Dial peer ..... 8
    - Intercom..... 8
    - Auto redial..... 8
    - Ring from headset..... 8
    - Hide DTMF ..... 8
    - Password dial..... 8
    - Predial ..... 8
    - Call logs ..... 9
    - Default line ..... 9
    - Auto switch line..... 9
  - Settings..... 9
    - Basic settings..... 9
      - Screen settings ..... 9
      - Ring settings ..... 9
      - Voice volume..... 9

Time & date .....	9
Language .....	9
Advanced settings .....	9
Accounts .....	9
Network.....	10
Network settings .....	10
QoS & VLAN.....	11
VPN .....	11
Web server type .....	11
Security .....	11
Menu password .....	11
Keyboard status.....	11
Keyboard password.....	11
Maintenance .....	12
Auto provision .....	12
TR069.....	12
Reset to Default .....	12
Applications .....	12
SMS .....	12
Memo.....	12
Voice Message.....	12
Ping.....	12
Phonebook.....	13
Contacts.....	13
Adding a contact.....	13
Editing a contact .....	13
Deleting a contact .....	13
Searching a contact .....	13
Groups .....	14
Add a group .....	14
Delete a group.....	14
Add a contact to a group.....	14
Add an existing contact to a group.....	14
Blacklist.....	15
Add a new contact to the Blacklist .....	15
Add an existing contact to the Blacklist .....	15
Cloud phonebook .....	15
LDAP.....	15
Speed dial .....	15
Adding a number to the Speed Dial.....	15
Call Logs .....	15
Reboot System .....	15

<b>Using the Phone .....</b>	<b>16</b>
Receiving a call .....	16
Placing a call .....	16
Ending a call .....	17
Redial .....	17
Diverting a call .....	17
Hold .....	17
Mute .....	17
Attendant transfer .....	17
Blind transfer .....	18
3-party conference .....	18
Call waiting .....	18
DND .....	18
Voicemail .....	18
<b>Troubleshooting .....</b>	<b>19</b>
Information .....	19
Troubleshooting guide .....	19
Character table to dial pad mode .....	20
<b>Warranty .....</b>	<b>21</b>



# Introduction



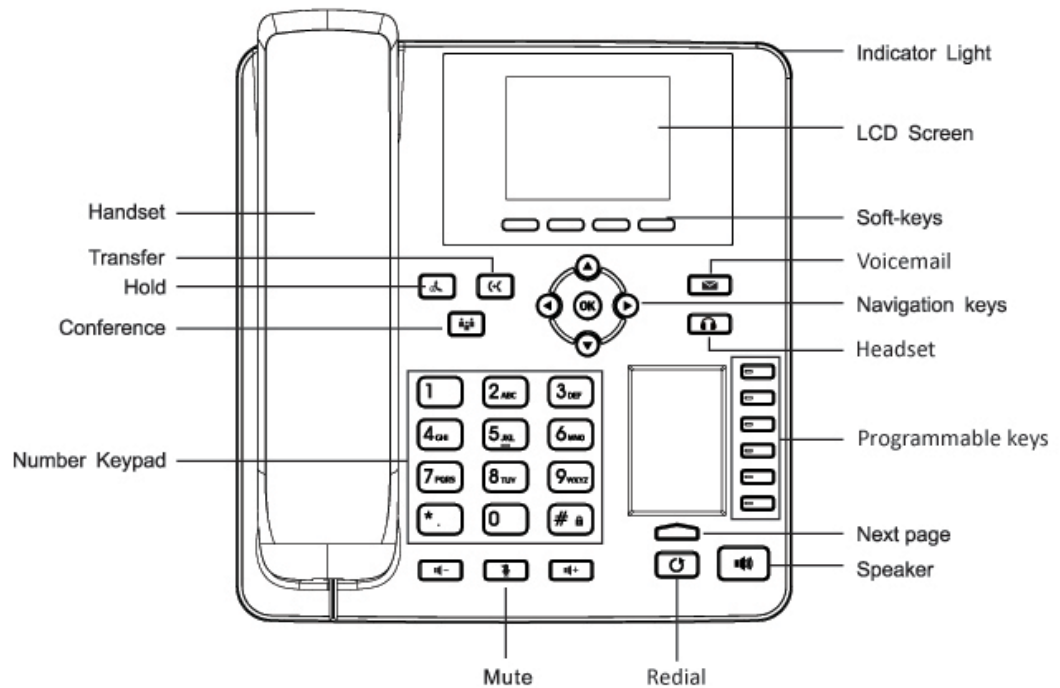

This user guide includes information about configuring and using your FON-375 IP phone.

## Phone features

- 2.8" color display
- Dedicated feature keys
- 18 programmable keys
- Full duplex speakerphone
- 2x 10/100/1000 Mbps ports allow you to share the network connection with your computer
- PoE support eliminates the need for a power adapter



Button	Function
	<i>Hold</i> — places and retrieves calls on hold.
	<i>Transfer</i> — transfers calls to another extension or outside line.
	<i>Conference</i> — brings multiple calls together in a conference.
	<i>Voicemail</i> — accesses voicemail and voicemail greetings.





Button	Function
	<i>Headset</i> – toggles the headset on and off.
	<i>Mute</i> – Toggles the microphone on and off.
	<i>Redial</i> – places a call to the last number dialed.
	<i>Speakerphone</i> – toggles the speaker on and off.

## Programmable keys

For information on how to configure the programmable keys, please consult the *FVE Admin Guide* located here: <http://www.fortivoice.com/support/documentation/index.html>.

## Display layout

The phone has a 2.8" screen with a 320 x 240 resolution, used to display information to the user, such as the time and date, as well as various status icons.

Icons	Descriptions
	Ringer is turned off
	New voicemail
	Missed calls
	New SMS messages
	Do Not Disturb is enabled

The bottom line shows choices associated with the 4 context-sensitive softkeys located just below the display.



# Installation

## Attaching the stand

### For desktop use

1. Line the 4 posts on the top of the base up with the 4 holes on the back of the phone.
2. Slide sideways into place until secure.

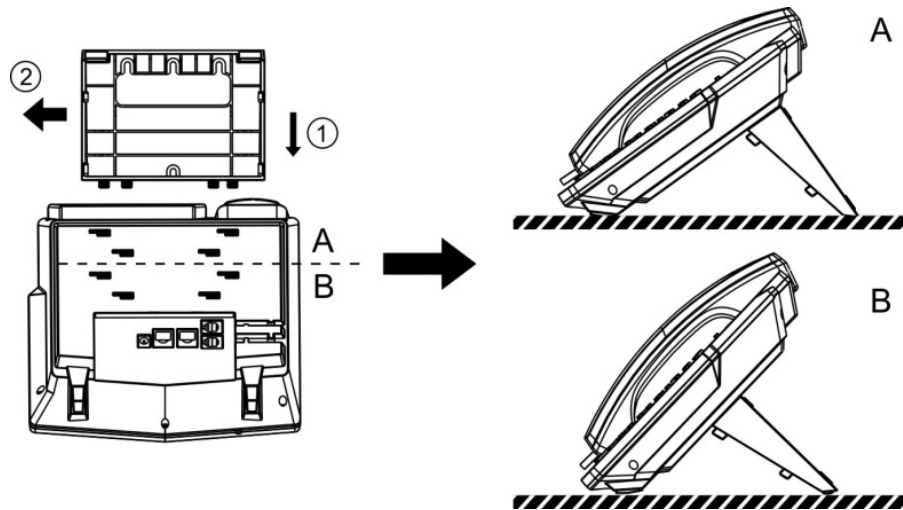

### For wall mounting

1. Attach top part of base to the phone.
2. Mark and drill three 5/16" (7 mm) holes according to their placement on the base.
3. Insert plastic wall anchors (not included) into the holes. Place a screw into the bottom hole, leaving about 1/8" (2.5 mm) exposed.
4. Slide the base over the bottom screw. Secure the base using screws in the top two holes.
5. Slide the phone onto the base and ensure the phone is secure. It may be necessary to remove the phone and tighten or loosen the screws for secure mounting.

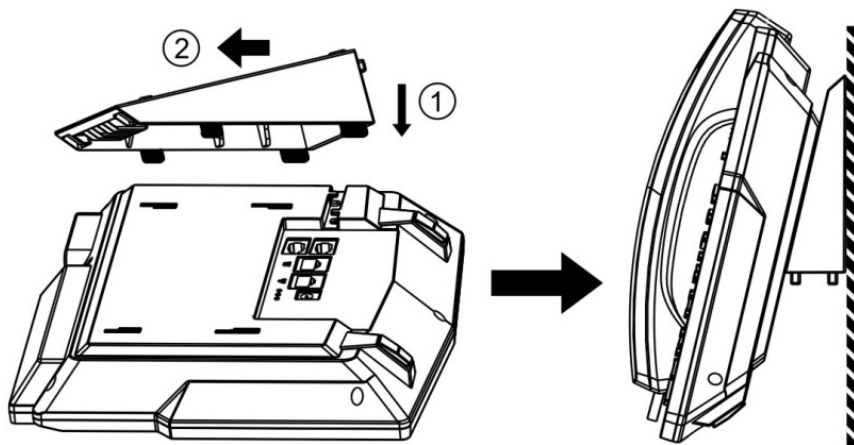

## Connecting the phone

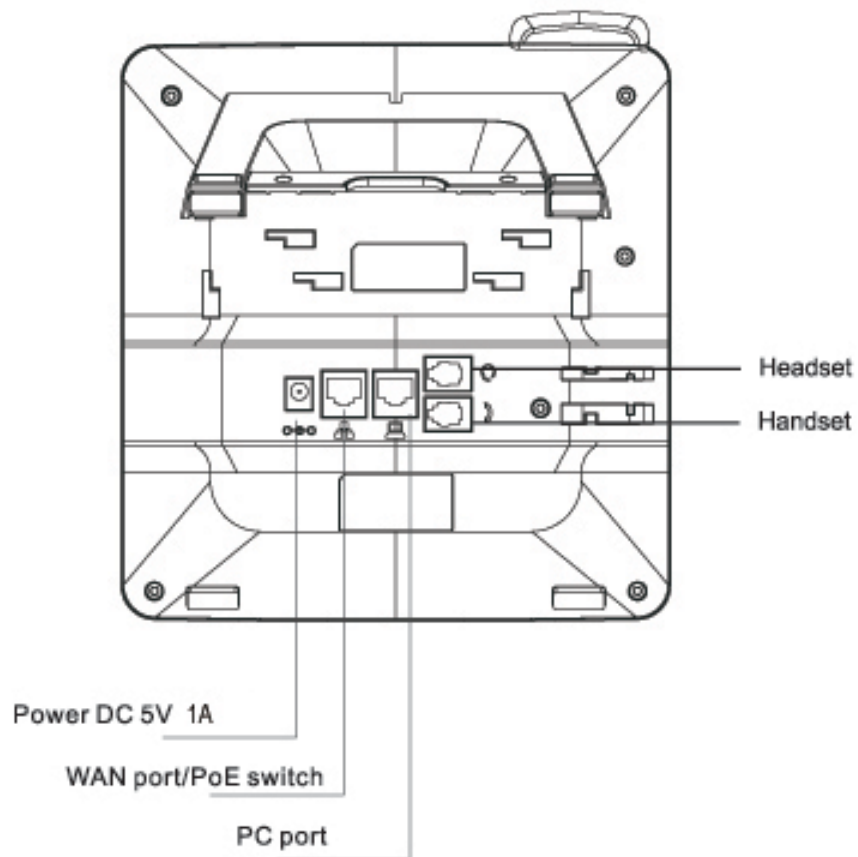

1. Connect the handset cord to the handset and the 📞 jack on the phone.
2. Optionally connect an amplified headset to the 🎧 jack.
3. Connect the WAN port to the network with the provided Ethernet cable.
4. Optionally connect your desktop PC to the PC port with an Ethernet cable (not supplied).
5. If the network supports PoE, a power adapter is not required. The phone requires 5.7 W to function with PoE. If PoE is not supported on the network, connect the power adapter to the DC 5V 1A power jack.

## Setting up the phone

### For use as an internal extension

The phone supports plug and play installation and will automatically download its configuration from the FortiVoice system. The phone will display the extension number and name when it has registered.

Once configured within the FortiVoice system, reboot the phone to download its configuration and register to the system.

### For use as an external extension

1. On the phone, press the *Menu* softkey.
2. Select *Settings*.
3. Select *Advanced Settings*.
4. Enter the *Password* as 23646.
5. Select *Maintenance*.
6. Select *Auto Provision*.
7. Select *Static Provisioning Server*.
8. Set the *Mode* to *After Reboot*.
9. Press the down arrow and set the *Protocol* to *TFTP*.
10. Press the down arrow and set the *Server* as the public IP Address of the FortiVoice.
11. Press *Save*.
12. Return to the *Main Menu* and select *Reboot System*.

# Personalizing your Phone

## How to navigate through menus

To access the configuration menu:

- Press the *Menu* softkey.

To select an item:

- Use the arrow keys to select an item and then press *OK*.

The bottom line of the display shows up to 4 softkey functions at a time. To return to a previous menu, press the *Prev.* softkey.

To exit the configuration menu, press the *Exit* softkey.

## Entering values with the dial pad and softkeys

Use the dial pad to input numbers, letters, special characters, and a period. The dial pad mode is displayed above the second softkey as **123** for numeric, **ABC** for uppercase characters, **abc** for lowercase characters and **2aB** to be able to enter any of the characters.

To enter characters with the dial pad, use the digit with the desired character. Press the same digit repeatedly until the desired character appears on the screen. After entering a character, pause to allow the cursor to move to next character position.

Other special entries include:

- To enter a period or dot (for example, to input an IP address), press **\*** on the dial pad.
- To delete a letter in front of the cursor, press the *Delete* softkey.
- To enter special characters, press **1** on the dial pad while the mode softkey is set to **ABC**, **abc** or **2aB**.
- To enter a space, press **0** on the dial pad while the mode softkey is set to **ABC**, **abc** or **2aB**.

Prior to saving an entry, you may discard changes by pressing the *Back* softkey to move to the previous menu.

# Configuration Overview

The phone supports the access and configuration of many parameters directly from the Telephone User Interface. To access the *Configuration* menu, press the *Menu* softkey while the phone is not in use.

The *Configuration* menu consists of several sub menus as listed below:

- Status
- Features
- Settings
- Applications
- Phonebook
- Call Logs
- Reboot System

## Status

The *Status* page includes the network Mode, IP address and Software version of the phone. Selecting the *More* option provides more details about the phone, the network connections and the registration status.

## Features

The features here should be handled on the FortiVoice system and configured by the system administrator. Making changes to these features on the phone is not recommended.

### Auto hangup

If enabled, the phone can automatically hang up and return to dial tone after the set amount of time.

### Call waiting

Enable/disable the Call Waiting feature as well as the tone that is played.

### DND

Enable/disable Do Not Disturb.

### Blocking anonymous call

Enable/disable the option to block calls that use Anonymous as the caller ID.

### Ban outgoing

Enable/disable the ability to make calls from the phone.

## Dial peer

This feature can be used to make dialing longer numbers easier by creating rules for them. The following fields can be configured for creating dial rules:

**Phone Number** — Enter the number to be dialed to trigger a match. There are two types of matches; Full Match and Prefix Match. The Full Match will be triggered by the entire number being dialed and must match exactly. The Prefix Match uses a wild card of T. For example; entering 9T here will trigger the dial rule when 9 is dialed, followed by any other number. Prefix Match will allow a maximum of 30 digits.

**Destination** — Set the Destination address. This is used for IP direct calls.

**Port** — Set the signal port. The default for SIP is 5060.

**Alias** — This setting can replace a phone number, add numbers, delete numbers or replace specified characters. Enter these commands to take advantage of the Alias:

- *all: xxx* — xxx will replace the phone number.
- *add: xxx* — xxx will be dialed before the phone number.
- *del* — the characters will be deleted from the phone number.
- *rep: xxx* — xxx will be substituted for the specified characters.

**Suffix** — Digits entered here will be added to the end of a matching phone number.

**Delete Length** — Set the number of digits to be removed from the beginning of the matching phone number.

## Intercom

Enable/disable Intercom functionality.

## Auto redial

Enable/disable the option to automatically redial a number that is busy or rejected. The redial can be timed to occur at specified intervals and given a set amount of times to try the redial.

## Ring from headset

Enable/disable ring tone heard on the headset.

## Hide DTMF

Enable/disable the option to hide DTMF digits from being displayed on the screen.

## Password dial

Enable/disable the option to hide a specific set of numbers. The Prefix is the number used to trigger hiding the number; the Length is how many numbers after the Prefix you would like to have hidden.

## Predial

Enable/disable the option to predial numbers. When enabled, the phone will not open an audio channel immediately while dialing a number.

## Call logs

View all calls to and from the phone.

## Default line

If enabled, the default line to make outbound calls can be selected.

## Auto switch line

If enabled, the phone will choose the first available line when making an outbound call.

# Settings

## Basic settings

### Screen settings

The screen of the phone can be set to always be on or to dim after a specified period of time.

### Ring settings

The *Ring Volume* can be changed here for both the handset and headset modes. The phone also supports different ring tones which can be set here under the *Ring Type*.

### Voice volume

This setting allows the user to change the volume heard at the handset, hands-free speaker and headset.

### Time & date

The *Time & Date* can be set to be obtained automatically or manually. The manual settings allows the user to change the *Timezone*, *Location*, set *Daylight Saving Time*, *12-hour Clock*, *Date*, *Time* and the date *Format*.

### Language

The phone supports many languages which can be selected here. This setting will only adjust the language on the screen of the phone. To change the audio prompts, the language of the extension must be set within the FortiVoice.

## Advanced settings

The default password to enter the advanced settings is 23646.

### Accounts

The *Accounts* section contains parameters to allow the phone to register to a SIP server or PBX. Contact your administrator before proceeding.

## Basic settings

The following fields will be configured automatically through the FortiVoice. To make any changes to these settings, contact the system administrator:

- *Registration*: enable or disable the account. Enabled accounts will try to register using the configured settings.
- *Server Address*: enter the IP address of the service to register with.
- *Server Port*: enter the port to register with the server on.
- *User Name*: the phone number or extension number of the account.
- *Auth User*: enter the authentication username for this account.
- *Auth Password*: enter the authentication password for this account.
- *Display Name*: the caller ID that will be displayed when calling other phones. When connected to a FortiVoice system, the caller ID information will be configured in the web-based interface.
- *Outbound Proxy*: set the IP address or FQDN of the outbound proxy.

## Advanced settings

The following fields will be configured automatically through the FortiVoice. To make any changes to these settings contact the system administrator:

- *Domain Realm*: enter the Realm for the account.
- *Dial Without Registered*: enable/disable this feature to make calls through a proxy server with no registration required.
- *Anonymous*: enable anonymous Caller ID using either RFC3323 or RFC3325.
- *DTMF Mode*: set the way that the phone sends DTMF.
- *Use STUN*: enable/disable the STUN setting.
- *Local Port*: set the port that the phone will use for registration.
- *Ring Type*: change the ring tone that this particular account will use when receiving a call.
- *MWI Number*: enter the information needed for the phone to subscribe to a message waiting indicator.
- *Pickup Number*: enter the Pickup Number for the system.
- *Park Number*: enter the Park Number for the system.
- *Join Call Number*: enter the Join Call Number for the system.
- *Missed Call Logs*: enable/disable the option to show missed calls to this account.
- *Feature Sync*: enable/disable Feature Sync with the server.
- *SCA*: enable/disable Shared Call Appearance.

## Network

### Network settings

#### Connection mode

The *Connection mode* contains the options for how the phone will connect to the network:

- DHCP
- PPPoE
- Static IP



### Static IP settings

The phone can be set up with a static IP address using these settings:

- IP Address
- Subnet Mask
- Gateway
- DNS1
- DNS2

### DHCP settings

Enable/disable the phone from obtaining an IP address using DHCP.

### PPPoE settings

Configure the *Username* and *Password* necessary to use PPPoE.

### QoS & VLAN

These settings for QoS and VLAN can be enabled/disabled here:

- LLDP
- QoS
- WAN VLAN
- LAN VLAN

Once a setting is enabled, press the down arrow button on the phone to view and configure the next setting.

### VPN

Enable/disable and configure the VPN settings here.

### Web server type

The *Web Server Type* can be set here as either *HTTP* or *HTTPS*.

## Security

### Menu password

The password to access the *Advanced Settings* can be changed here.

### Keyboard status

Enables/disables the Keylock feature, which will lock the dialpad and require a password to unlock.

### Keyboard password

Set the password to unlock the keyboard if the Keylock feature is enabled.

## Maintenance

### Auto provision

#### DHCP option

Set the *DHCP Option* to automatically provision the phone:

- Option 43
- Option 66
- Custom 128–254 (if selected, press the down arrow to enter the value for this option)
- Disabled

#### SIP Plug and Play

Enable/Disable the SIP Plug and Play options.

#### Static Provisioning Server

Enable/disable the use of a Static Provisioning Server. If enabled, press the down arrow on the dial pad to access additional settings.

### TR069

#### Settings

Enable/disable the use of TR069. If enabled, press the down arrow on the dial pad to access additional settings.

#### Status

If TR069 has been configured, this section will display status updates.

## Reset to Default

This will default all of the settings on the phone.

## Applications

### SMS

View SMS messages.

### Memo

The phone can bring up a short notification based upon a specified time.

### Voice Message

Displays the amount of new and total voicemail messages for this extension.

### Ping

The Ping feature can send a ping out to a specified IP address.

# Phonebook

## Contacts

The phone supports up to 500 contacts. Each contact can have up to 3 phone numbers and a ring tone assigned. When a call is received from the contact, the specified ring tone overrides the default one.

### Adding a contact

To add a contact:

1. Press the *Add* softkey.
2. Edit the following fields:
  - *Name*: name of the contact.
  - *Tel*: phone number.
  - *Mobile*: mobile phone number.
  - *Other*: additional phone number field.
  - *Ring*: the ring tone that will be used when receiving calls from this contact.

### Editing a contact

To edit a contact:

1. Select a contact.
2. Press the *Option* softkey.
3. Select *Edit*, press *OK*.
4. Edit the information.
5. Press the *Save* softkey.

### Deleting a contact

To delete a contact:

1. Select a contact.
2. Press the *Option* softkey.
3. Select *Delete*. Press *OK*.

### Searching a contact

To search for a contact:

1. Press the *Option* softkey.
2. Select *Search*.
3. Enter part of a number or name to search for.
4. Press the *OK* softkey.

## Groups

Contacts can be added to specific groups such as Friends, Work, Businesses, etc, keeping your contacts organized.

### Add a group

To add a new group:

1. Press the *Option* softkey.
2. Select *Add*.
3. Press the *OK* softkey.

### Delete a group

To delete a group:

1. Press the *Option* softkey.
2. Select *Delete*.
3. Press the *OK* softkey.

### Add a contact to a group

To add a contact:

1. Select a group to add a contact to.
2. Press the *Enter* softkey.
3. Press the *Add* softkey.
4. Edit the following fields:
  - *Name*: name of the contact.
  - *Tel*: phone number.
  - *Mobile*: mobile phone number.
  - *Other*: additional phone number field.
  - *Ring*: the ring tone that will be used when receiving calls from this contact.

### Add an existing contact to a group

1. Press the *Menu* softkey.
2. Select *Contacts*.
3. Select the contact you would like to add to the group.
4. Press the *Option* softkey.
5. Select *Groups*.
6. Select the group you would like to add the contact to.
7. Press the *Save* softkey.

## Blacklist

Adding a contact to the Blacklist will prevent the contact from being able to call this extension.

### Add a new contact to the Blacklist

1. Press the *Add* softkey.
2. Select the *Type* you would like to add: *Number* or *Prefix*.
3. Enter the *Value*, either the number or prefix.
4. Choose which *Line* to have the number or prefix blacklisted on.

### Add an existing contact to the Blacklist

1. Press the *Menu* softkey.
2. Select *Contacts*.
3. Select the contact you would like to add to the blacklist.
4. Press the *Option* softkey.
5. Select *Blacklist*.
6. Press the *Save* softkey.

## Cloud phonebook

The Cloud Phonebook is a list of contacts hosted by a server on the network.

## LDAP

The LDAP settings allow for retrieving a contact list from a LDAP server.

## Speed dial

The phone can store up to 9 custom speed dial numbers.

### Adding a number to the Speed Dial

1. Select the *Speed Dial* to create.
2. Press the *Edit* softkey.
3. Enter the *Name* of the speed dial.
4. Enter the number to dial under *Tel*.
5. Choose the *Line* to call out on.
6. Press the *Save* softkey.

## Call Logs

The phone stores up to 100 calls in the Call Log, displaying inbound, outbound and missed calls.



## Reboot System

Selecting this option will reboot the phone.

# Using the Phone

## Receiving a call

When you receive a call, the phone will display the call details and the ring indicator will flash. The phone will also ring unless the ringer is off.

- To answer the call with the handset, lift the handset.
- To answer the call with the speakerphone, press  or the *Answer* softkey.
- To answer the call with the headset, press .

If your extension has call waiting enabled, you can press the *Answer* softkey to answer the second call.

To reject a call, press the *Reject* softkey. The call will follow the extension's *Busy* settings as configured in the *Call handling* section.

## Placing a call

You can place a call by dialing a number, selecting a number from the call log or a contact from the phone book.

To dial an extension number:

1. Dial the extension number.
2. After about 4 seconds, the phone will dial the number. Optionally, press *OK*, the *Send* softkey or  to place the call immediately.

To dial an outside number:

1. To access an outside line, dial the outgoing access code (for example: 9 or 0) if configured within the Fortivoice.
2. Dial the phone number.
3. After about 4 seconds, the phone will dial the number. Optionally, press *OK*, the *Send* softkey or  to place the call immediately.

To dial a number from the call log:

1. Press the *History* softkey.
2. Select a call log entry. Press the *Dial* softkey.



To dial a number from the phone book:

1. Press the *Phonebook* softkey.
2. Select the Phonebook option you would like to dial from.
3. Select *Contact*.
4. Press the *Dial* softkey.

By default, all calls will use the speakerphone. Lift the handset if you wish to place a call using the handset. Press  if you wish to place a call using the headset.



## Ending a call

To end a call:

- Press the *End* softkey.
- If you are using the handset, place it in the cradle.
- If you are on speakerphone, press .
- If you are using a headset, press .

## Redial

Allows you to redial the last number dialed:

- Press . The phone activates the speakerphone and places the call.
- You can also lift the handset or press  followed by pressing .

## Diverting a call

While the phone is ringing during an incoming call, the call may be diverted to another extension without answering. To divert a call:

1. Press the *Divert* softkey.
2. Enter the extension number to divert the call to.
3. Press the *Divert* softkey.



## Hold

To place calls on hold press the *Hold* softkey. While a call is on hold you can answer or place other calls. The held party will hear music, if configured to do so.

To toggle between two calls, use the navigation keys and press the *Answer* or *Resume* softkey. To retrieve a call held on a different line, double press the flashing L1 or L2 key associated with the call on hold.

## Mute

Mute turns the phone's microphone on or off.

1. Press  to disable the microphone. The mute button will turn red and *Mute* will appear on the display.
2. Press  again to enable the microphone.

## Attendant transfer

Calls can be announced to the party receiving the transfer before completing the transfer.

To perform an attendant transfer:

1. Press the *L1* or *L2* key.
2. Dial the extension or phone number.
3. Announce the call.
4. Press the *Xfer* softkey.

## Blind transfer

Calls can be transferred without talking to the party receiving the transfer.

To perform a blind transfer:

1. Press the *Xfer* softkey.
2. Dial the extension or phone number.
3. Press the *Dial* softkey.

## 3-party conference

The phone supports conferencing with two other parties.

To create a 3-party conference:

1. Place the first call.
2. Press the *Conf* softkey, the first call will be placed on hold.
3. Call the second party for the conference.
4. When the second party answers, press the *Conf* softkey again.

To end a conference call:

1. Press the *Split* softkey to separate the parties from the conference.
2. Press the *End* softkey to end the conference call. Both parties will be disconnected.

## Call waiting

When Call Waiting is enabled, the phone will present new calls to you while you're on a call. In order to use Call Waiting, it will first need to be enabled in the FortiVoice interface.

To answer an incoming call while on a call, press the flashing *L1* or *L2* key. Alternately, use the navigation keys to view the caller and then press the *Answer* softkey. The initial call will be placed on hold. Refer to the *Hold* section on how to toggle between calls.

## DND

When DND (Do Not Disturb) is enabled, you will not be notified of incoming calls.

1. Press *DND* softkey to enable DND. The DND status icon will be displayed.
2. Press the *DND* softkey again to disable DND.

## Voicemail

When you have a message waiting, the message indicator flashes and the voicemail icon appears to indicate you have new messages in your mailbox.

To access your voice mailbox:

- Press  or the *View* softkey.



# Troubleshooting

## Information

Pressing the *OK* button on the phone provides the means to quickly view the network parameters (IP address, default gateway address, and subnet-mask), registration status of the phone, MAC address and firmware version. This information may be useful if calling Fortinet Support.

## Troubleshooting guide

Symptoms	Corrective actions
Display is blank	Confirm the phone's power source. <ol style="list-style-type: none"><li>If you are using the power adapter:<ul style="list-style-type: none"><li>Ensure it is plugged in. If it still doesn't work, replace the power adapter.</li></ul></li><li>If you are using Power over Ethernet (PoE):<ul style="list-style-type: none"><li>Ensure your Ethernet cable is plugged into the INTERNET port on the back of your phone.</li><li>Ensure the PoE switch is properly configured. If it still doesn't work, replace the Ethernet cable.</li></ul></li></ol>
Phone not obtaining an IP address	The DHCP server is not responding. <ol style="list-style-type: none"><li>Ensure your DHCP server is online. This is typically your router.</li><li>Reboot the router or DHCP server.</li><li>If you are still experiencing issues, the phone may require advanced network configuration. Contact your administrator.</li></ol>
Phone will not register	Your phone is not registered. <ol style="list-style-type: none"><li>On the <i>Extension</i> page of the FortiVoice interface, ensure the MAC address is correctly entered and the <i>Phone Type</i> is <i>FON-375</i>. Save your configuration and reboot the phone.</li><li>On the phone, ensure the TFTP IP address is correct. To verify, see <a href="#">"For use as an external extension" on page 5</a></li><li>If your phone is configured as an external extension, check the network connection and firewall settings at the phone system location.</li></ol>
No audio during a call	<ol style="list-style-type: none"><li>Check the handset/headset connections.</li><li>Make sure the phone is properly registered with the phone system.</li><li>If your phone is configured as an external extension, check the network connection and firewall settings at the phone system location.</li></ol>

## Character table to dial pad mode

Digit	Dial Pad Mode			
	abc	ABC	2aB	123
1			1	1
2	abc	ABC	2 a b c A B C	2
3	def	DEF	3 d e f D E F	3
4	ghi	GHI	4 g h i G H I	4
5	jkl	JKL	5 j k l J K L	5
6	mno	MNO	6 m n o M N O	6
7	pqrs	PQRS	7 p q r s P Q R S	7
8	tuv	TUV	8 t u v T U V	8
9	wxyz	WXYZ	9 w x y z W X Y Z	9
0	Space	Space	0 Space	0
*	#@,.;?\${}%&()<>[]~!_+=-?	#@,.;?\${}%&()<>[]~!_+=-?	*	*
#			#	#

# Warranty

This phone is covered by a one-year hardware warranty against manufacturing defects as set forth in the EULA.

[www.fortivoice.com/support](http://www.fortivoice.com/support)

For warranty service:

- *In North America*, please call 1-866-648-4638 for further information.
- *Outside North America*, contact your sales representative for return instructions.

You will be responsible for shipping charges, if any. When you return this telephone for warranty service, you must present proof of purchase.

